



Experiment No. 2. Voltage Dividers, DC & AC Signals, and Batteries

By: Prof. Gabriel M. Rebeiz
The University of Michigan
EECS Dept.
Ann Arbor, Michigan

- Read Chapters 1-3 in the additional course notes (Audio Electronics & Batteries).
- Read this experiment and answer the pre-lab questions before you come to the lab.

1.0 Voltage Divider; KVL and KCL Rules:

- Equipment:**
- Agilent 34401A Multimeter
 - Agilent E3631A Triple Power Supply

Experiment Set-up:

1. Measure the resistance of the 1 K Ω , 2.4 K Ω and 5.1 K Ω resistors using the Agilent 34401A multimeter.
2. Connect the following circuit on your proto-board. You should have learned the layout of the protoboard and how to put components in it during the Lab Lecture. If in doubt, ask you lab instructor for help.

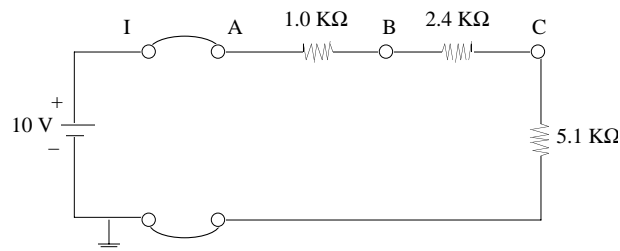

3. Connect the Agilent E3631A power supply to your circuit and set it at +10V.
4. Using the Agilent 34401A multimeter, measure the node voltages V_A , V_B , V_C (with respect to ground).
Also, measure the voltage drop, V_{AB} and V_{BC} . Check that the KVL rule is satisfied around the loop.
Compare the measured voltages with your pre-lab calculations.
5. Break the circuit at node A (or node B or node C), and measure the current I in the circuit using the Agilent 34401A multimeter.



Compare this value with your pre-lab calculation: Write down a brief statement summarizing this comparison, but you may calculate the percentage difference in your post-lab.

- 6. Connect now the 3.3 KΩ and 4.7 KΩ resistors from node C to ground as shown below:

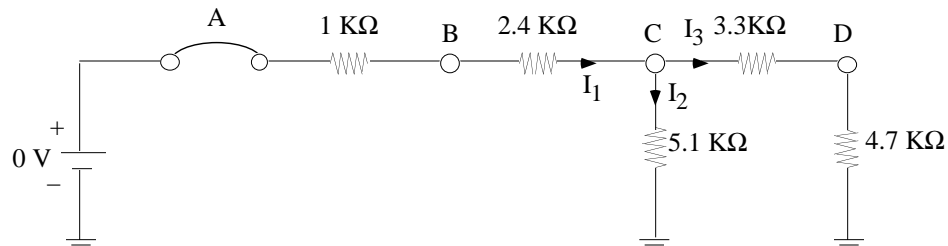

- ❑ Measure the 3.3 KΩ and 4.7 KΩ resistors using the Agilent 34401A multimeter.
- ❑ Measure V_A , V_B , V_C , V_D with respect to ground. (Be sure that the Agilent 34401A multimeter is set for voltage measurement).
- ❑ Measure the currents I_1 , I_2 , I_3 . Check that the KCL rule is satisfied. Write a brief statement on the validity of KCL, based on your measurements.

In the lab report, you will be asked questions about this section.

2.0 Linear Circuits in Time Domain:

Turn off the power supply.

Disconnect your circuit board from the power supply (remove both cables with banana plugs).

1. Set the Agilent 33120A to give a 10 kHz sinewave with $V_{ppk} = 2$ V and connect it to circuit of page 30. Use a cable with a BNC connector on one end and two alligator clips (for the signal and ground connections) on the other end. Use probe wires, connect them to node A and the ground of your circuit.

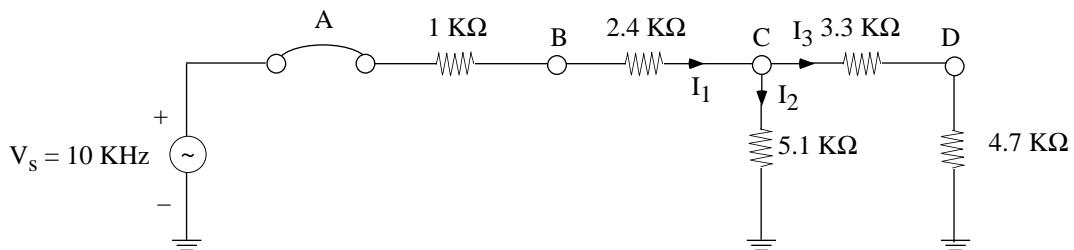

2. ❑ Measure V_{Bppk} , V_{Cppk} and V_{Dppk} and plot the waveforms on your notebook (voltage vs. time).
3. Set the source to give a 10 kHz triangular wave with $V_{ppk} = 2$ V.



- Measure $V_{Cp_{pk}}$ and $V_{Dp_{pk}}$ and plot the input (V_S) and output waveforms (V_C , V_D) on your lab notebook.

(You will note that in linear circuits, the output signals have exactly the same shape as the input signal but with different amplitudes.)

3.0 Batteries and Internal Resistance:

Equipment: Agilent 34401A Multimeter

As seen in Chapter 2 of Additional Course Notes, the battery voltage may be around 1.4-1.5V when open circuited (no current) and drops to 1.3-1.4V when in operation. Actually, the battery voltage depends on the discharge current and time. A nice way to model this voltage drop is to include an internal resistance (R_b) in the battery model. Figure on p. 32 shows an ideal battery and a real battery. Notice that we cannot access the inside nodes of R_b and therefore, the internal resistance is calculated from measured external V/I values:

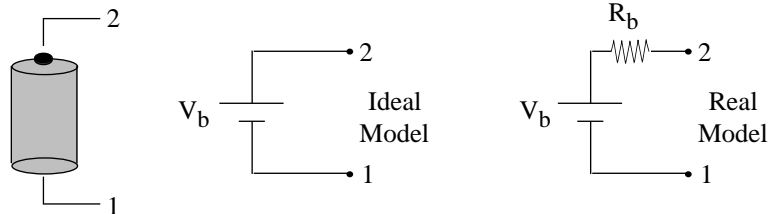

For a new C-type battery with a full rated capacity of 7100 mAH, the internal resistance can be as low as $0.1-0.2 \Omega$ at a 500 mA discharge current (50 mV–100 mV drop). When the battery is 1/3 full (66% of the capacity is *removed*), the internal resistance will increase to around 0.6Ω (0.3 V drop). If the battery is nearly empty, the internal resistance will be as high as $1-2 \Omega$ resulting in a voltage drop of 0.5–1 V (from a 1.5V source) and making the battery useless.

Experiment Set-Up:

1. Take two C-type batteries and connect them in series.
 - a. Measure the open-circuit voltage, $V_b = V_{OC}$ (no current from the batteries). It should be around 2.5–2.9V, depending on the “age” of the batteries.
2. Connect a 10Ω load resistor across the battery terminals.
3. Connect an ammeter in the circuit loop.

Remember: Current is measured **in series** in a circuit loop.
 Voltage is measured **in parallel** across an element.
 Refer to p. 12-13 of this Manual.



The experiment should look like this:

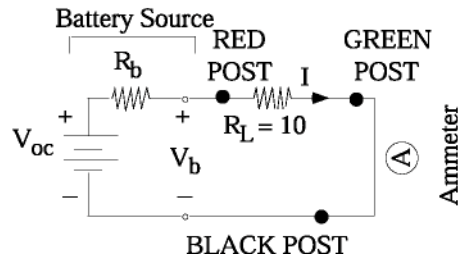
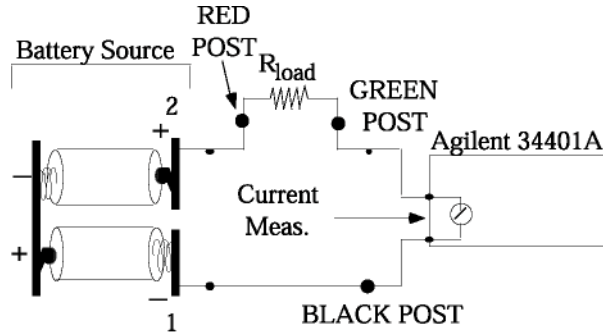

$$V_b = V_{oc} - IR_b$$

Before you start, ask your lab instructor to check the circuit!

For a load resistor of 10 Ω:

1. Measure the current in the loop (I).
 2. Measure the voltage across the battery terminals (V_b).
 3. Repeat steps 1 and 2 every minute or so for a total of 3 measurements.
- Calculate the internal resistance of the “battery source” for all three measurements. Notice, this is the resistance of two C-cell batteries in series. What is the internal resistance of one C-cell battery for each case?

4.0 Sawtooth Waveform in Time and Frequency Domain:

1. Set the Agilent 33120A waveform generator to give a 10 KHz, 3 Vppk sawtooth waveform. Connect the function generator to the scope.
2. Measure the waveform period and peak-to-peak amplitude using the cursors function. Sketch the waveform (several periods) in your lab notebook. Pay attention to the slope of the sawtooth since you will need it in your lab report.
3. Go to the frequency domain (review p. 21-22 for the FFT set-up). Measure the frequencies in kHz and amplitudes in dBV of the fundamental (f_0) and the harmonics ($2f_0$, $3f_0$, $4f_0$, $5f_0$, $6f_0$). Note that unlike the square-wave spectrum, the sawtooth spectrum does contain both even and odd harmonics. Record your data in a table form.



Experiment No. 2. Voltage Dividers, DC & AC Signals, and Batteries

Pre-Lab Assignment

1. Calculate V_A , V_B , V_C and I in the circuit of experiment #1 (on p. 30) for a 10V DC input voltage.
2. a. Calculate the time it takes for the C-type battery with a full rated capacity of 7100 mAh to reach its 1/3 capacity value, at a discharge current of 200 mA.
b. The measured open-circuit voltage of a battery ($V_b = V_{OC}$) is 1.5 V. The measured output voltage is 1.24 V for a 500 mA discharge current. Calculate the internal resistance value (R_b).
c. A unit requires three AA 1.5 V batteries connected in this fashion. What is the operating voltage (V_b) of the unit?

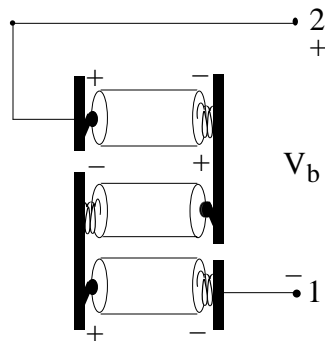



Experiment No. 2

Voltage Dividers, DC & AC Signals, and Batteries

Lab Report Assignment

- Using the measured values of the resistors, calculate V_A , V_B , V_C and I for the circuit on p. 30. Compare with measurements (down to mV levels), and show difference in percent. Comment on your results.
- For the circuit with the additional 3.3 k Ω and 4.7 k Ω resistors (on p. 31), calculate V_A , V_B , V_C , V_D , I_1 , I_2 , I_3 and compare with measurements and show difference in percent. Comment on your results.

Why did V_C change? Explain using KVL and KCL (as clearly as you would do it on a mid-term).

- Summarize your measurements of the battery circuit. State V_{OC} and R_S of each battery. From the measured battery voltage (V_b) under a 10 Ω load, calculate the power delivered by the battery to the load. Also, using the internal resistance of the battery, calculate the power dissipated in the battery. Estimate the percent of capacity removed using Fig. 3.7 in the additional course notes.
- a) Take the measured amplitudes (V_{rms}) of the 10 kHz sawtooth signal at f_0 , $2f_0$, $3f_0$, $4f_0$, $5f_0$, $6f_0$, and plot the following waveform from $t=0$ to $t=0.5$ msec. The y-axis should be between -2 and +2 V.

$$\begin{aligned}
 V_1(t) = & \sqrt{2} V(f_0) \sin(2\pi(f_0)t) - \sqrt{2} V(2f_0) \sin(2\pi(2f_0)t) \\
 & + \sqrt{2} V(3f_0) \sin(2\pi(3f_0)t) - \sqrt{2} V(4f_0) \sin(2\pi(4f_0)t) \\
 & + \sqrt{2} V(5f_0) \sin(2\pi(5f_0)t) - \sqrt{2} V(6f_0) \sin(2\pi(6f_0)t)
 \end{aligned}$$

V in rms!

(The derivation of the Fourier series decomposition of a sawtooth signal can be found on pp. 699-701 of "*Electric Circuit Analysis*" by D.E. Johnson et al. (3rd Edition) as well as in many other textbooks.

- Using the same amplitudes of all 6 harmonics, plot:

$$\begin{aligned}
 V_2(t) = & \sqrt{2} V(f_0) \sin(2\pi(f_0)t) + \sqrt{2} V(2f_0) \sin(2\pi(2f_0)t) \\
 & + \sqrt{2} V(3f_0) \sin(2\pi(3f_0)t) + \sqrt{2} V(4f_0) \sin(2\pi(4f_0)t) \\
 & + \sqrt{2} V(5f_0) \sin(2\pi(5f_0)t) + \sqrt{2} V(6f_0) \sin(2\pi(6f_0)t)
 \end{aligned}$$

V in rms!

Compare $V_1(t)$ and $V_2(t)$ with your lab measurements. Write a brief comment.

Recall that $\sin(\omega t) = -\sin(\omega t + 180^\circ)$, and therefore $V_1(t)$ and $V_2(t)$ differ only by the phases of their even harmonic components. Notice that it is important to know the phase (or sign) of the harmonics to get the time domain representation from the frequency. The FFT spectra measured with Agilent 54645A oscilloscopes do not contain phase information.